

# Residential Swimming Pools

## Permit Requirements for Storable Swimming Pools



This packet contains general requirements that should be considered as part of your project and should not be considered as a complete list of all code requirements. Refer to the codes listed below for all requirements pertaining to swimming pool installation. All new swimming pools shall be constructed and installed in accordance with the applicable sections of the *2015 International Residential Code*, *2014 National Electrical Code* and the *2017 Uniform Code Supplement of New York State*. (These documents are available in the Code Enforcement Office by request.)

### PERMIT REQUIRED

A building permit is required for the construction or installation of any storable swimming pool that is capable of holding a depth of more than 24 inches of water. This includes any portable or storable pool. Any pool that contains a filter system, heater or electrical lighting also requires a building permit. A building permit must be obtained before any construction or installation may begin. Any change to an existing pool location, electrical component or barrier, will also require a new building permit.

### APPLICATION PROCESS

The following information must be submitted when applying for a building permit:

- Completed Application for Building Permit.**
- A scaled plot plan of the lot showing the following:**
  - Proposed pool location – show distances to property lines and adjacent structures.
  - House and adjacent structures including existing decks and patios.
  - Location of overhead or underground utility lines and easements. Show horizontal and vertical distance from edge of pool or spa to all electric lines.
  - Location, size and heights of all barrier enclosures including fences, and gates. Show location of all doors leading directly to pool area.
  - Location of gas lines, pool heaters, pumps, electrical: wiring, boxes, lighting and receptacles associated with the pool. Show distance from pool to these features.
  - Location of any deck constructed in conjunction with the pool. **(A separate building permit is required)**
- Workers' Compensation Document(s).** All permit applications require the following New York State Workers' Compensation Board documents be submitted prior to approval of a building permit.

**BP-1 Form** - This form may be submitted if YOU ARE THE OWNER of a 1, 2, 3, or 4 family, owner-occupied residence and meet one of the following criteria:

- You are performing all the work for which the building permit will be issued.
- You will not be hiring, paying or compensating in any way, the individual(s) that will be performing all of the work for which the building permit will be issued or helping you perform such work.
- You have a homeowners insurance policy that is currently in effect and covers the property listed on the building permit AND you will be hiring or paying individual(s) a total of less than 40 hours per week (aggregate hours for all paid individuals on the jobsite) for which the building permit will be issued.

Forms may be obtained in the Permit Office or printed at [www.charlotteny.org](http://www.charlotteny.org).

- OR -

**CE-200 Form** - If a contractor has been hired and he/she is doing the work is a sole proprietor or a partnership and has no employees, form CE-200 must be filed, for each project. This form can be completed and printed at [www.wcb.ny.gov](http://www.wcb.ny.gov) or by calling (866) 546-9322.

- OR -

If the contractor doing the work hires any part-time or full-time help or leases employees, the following proofs of insurance must be on file with this office naming the Town of Charlotte as the Certificate Holder:

- Certificate of New York State Workers' Compensation Insurance (CE-200, C-105.2, U-26.3 or SI-12)  
**ACORD forms are not acceptable proof of workers' compensation insurance.**
- Certificate of Insurance Coverage under the New York State Disability Benefits Law (CE-200, DB-120.1 or DB-155)

**Return the completed permit application, plans and associated documents and forms to the Village Clerk's office or mail to:**

Town of Charlotte  
Code Enforcement Department  
8 Lester Street, P.O. Box 482  
Sinclairville, New York 14782

Once the permit application, plans, associated documents and forms have been received by the Code Enforcement Officer, they will be reviewed within 5 business days. If approved, a building permit will be issued and you will be notified to pick up your permit at the Town Clerk's office. At that time you will be required to pay the appropriate permit fee. Checks may be made payable to the Town of Charlotte.

Upon receipt of payment, the applicant will be issued a permit placard which must be displayed throughout the installation process. Installation may not begin until the applicant obtains and displays the permit placard.

If the application is not approved, you will be notified in writing as to why it was not approved. You have the right to seek relief from a denied building permit by seeking a variance from the Zoning Board of Appeals. You will be given instructions regarding this process with your denial.

### **INSTALLATION REQUIREMENTS**

Once you have received your approved building permit and approved plans, the installation of your swimming pool may begin.

The building permit placard **MUST** be displayed in a conspicuous location on the building site until construction is complete and a Certificate of Compliance is issued.

Any deviation from the approved plans must be authorized by the approval of revised plans subject to the same procedure established for the examination of the original plans. An additional permit fee may be charged predicated on the extent of the variation from the original plans.

### **LOCATION**

Pools must not be placed below or above utility lines or within any easements. Any changes to the pool location, electrical service or barriers will require a new building permit. Town of Charlotte zoning laws will also dictate where the pool may be located on the property. Any changes to the pool location, electrical service or barriers will require a new building permit.

### **CALL BEFORE YOU DIG**

Care should be taken when excavating to minimize potential problems with buried gas, water, sewer and underground electrical lines. Applicants must obtain assistance regarding the location of underground utilities by calling Dig Safely New York at 811 at least two full working days prior to starting your work, not counting the day of your call, weekends or holidays.



### **POOL ALARMS**

Every swimming pool that is installed, constructed or substantially modified, must be equipped with an approved pool alarm which:

- is capable of detecting a child entering the water and giving an audible alarm when it detects a child entering the water;
- is audible poolside and at another location on the premises where the swimming pool is located;
- is installed, used and maintained in accordance with the manufacturer's instructions;
- is not an alarm device which is located on person(s) or which is dependent on device(s) located on person(s) for its proper operation.

A pool alarm must be capable of detecting entry into the water at any point on the surface of the swimming pool. If necessary to provide detection capability at every point on the surface of the swimming pool, more than one pool alarm must be installed.

**BARRIER REQUIREMENTS**

All pools and spas must be provided with safeguards to prevent children from gaining uncontrolled access to the pool or spa. To successfully restrict access to the pool or spa, an approved barrier must be constructed. A successful pool barrier prevents a child from getting OVER, UNDER or THROUGH and keeps the child from gaining access to the pool except when supervising adults are present.

The height of the barrier or fence must be at least **48"** above grade measured on the side of the barrier which faces away from the pool.

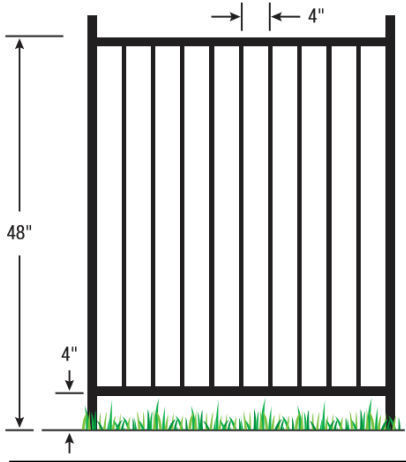

**For a Barrier (Fence) Made Up of Horizontal and Vertical Members:**

If the distance between the tops of the horizontal members is **less than 45"**, the horizontal members shall be located on the swimming pool side of the fence. The spacing between the vertical members shall not exceed **1-3/4"** in width. Where there are decorative cutouts within the vertical members in the fence, the spacing within the cutouts must not exceed **1-3/4"** in width.

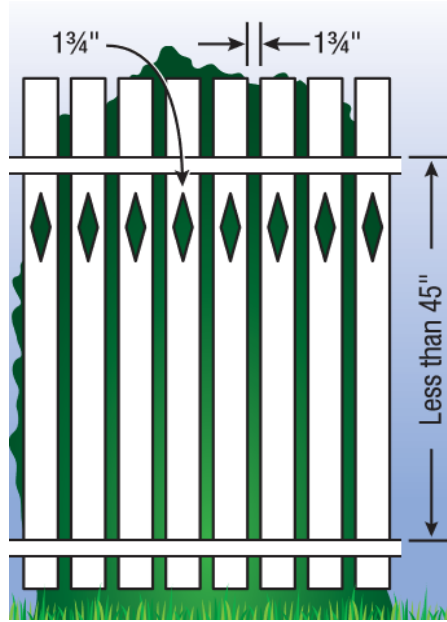

If the distance between the tops of the horizontal members is **more than 45"**, the spacing between vertical members must not exceed **4"** in width.

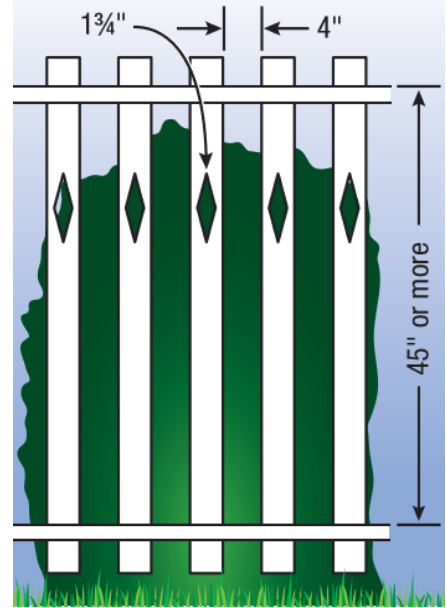

**For a Chain Link Fence:**

The mesh size should not exceed **2-1/4"** square unless the fence has slats fastened at the top or bottom which reduces the openings to not more than **1-3/4"** in width.

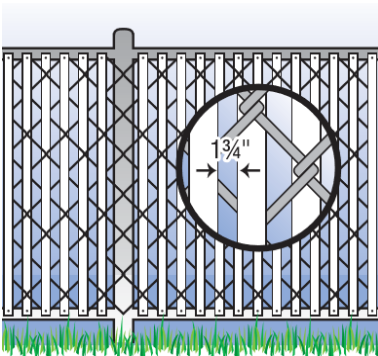
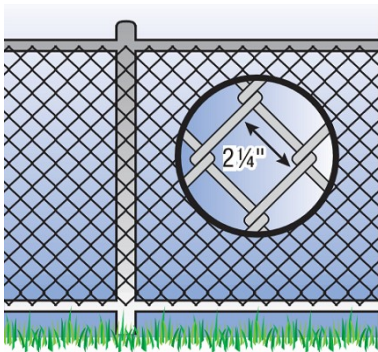

**For a Fence Made Up of Diagonal Members (Latticework):**

The maximum opening in the lattice should not exceed **1-3/4"**

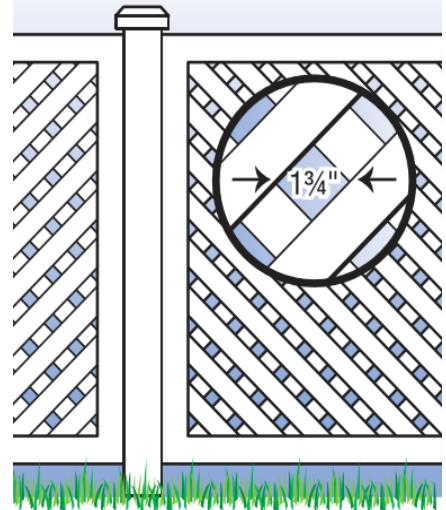

**For a solid barrier:**

No indentations or protrusions should be present, other than normal construction tolerances and masonry joints.

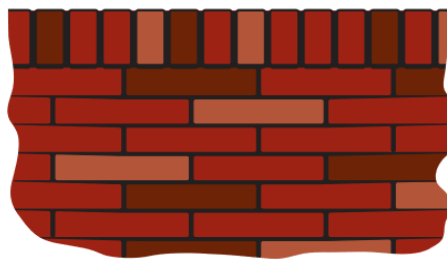

**Barrier Clearances:**

Where the adjacent grade slopes toward the pool, a minimum barrier height of 48" above grade must be maintained for minimum horizontal distance of 48" measured from the top edge of the pool.

Pool equipment must be placed at least 48" from the pool wall to prevent the equipment from being used for climbing.

For any pool barrier, the maximum vertical clearance between grade and the bottom of the barrier shall be 2" measured on the side of the barrier which faces away from the swimming pool. Where the top of the pool structure is above grade, such as an above-ground pool, the barrier may be at ground level, such as the pool structure, or mounted on top of the pool structure.

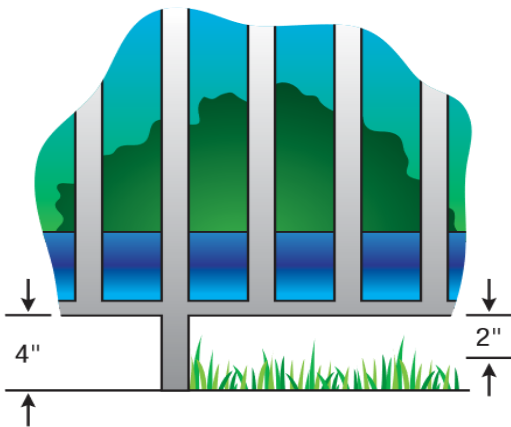

Where the barrier is mounted on top of the pool structure, the maximum vertical clearance between the top of the pool structure and the bottom of the barrier shall be 4".

To prevent a child from getting through a fence or other barrier, all openings should be small enough so that a 4" diameter sphere cannot pass through.

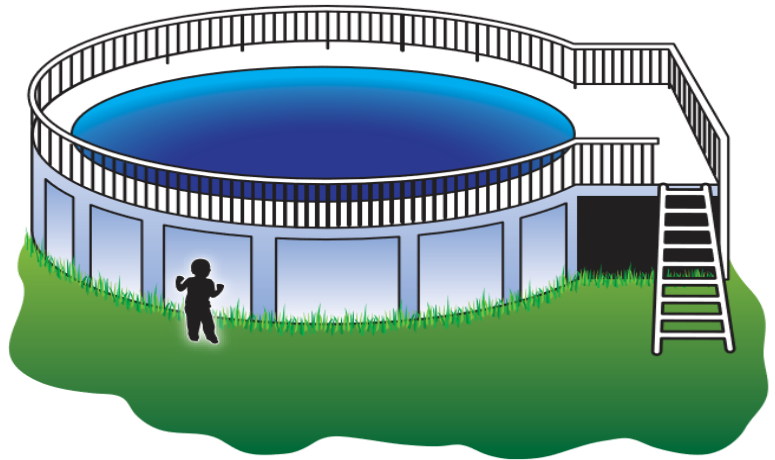
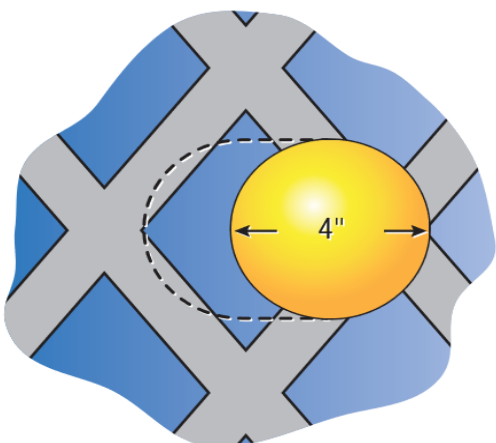

Above-ground pools must have barriers unless the structure itself meets the barrier height requirements. **The walls of portable, storable pools that are formed by the height of the water, require a solid barrier regardless of its size.** Where an above-ground pool structure is used as a barrier or where the barrier is mounted on top of the pool structure and the means of access is a ladder or steps, the ladder or steps shall be capable of being secured, locked or removed to prevent access. Permanently installed ladders or steps must be protected by an approved fence and gate.

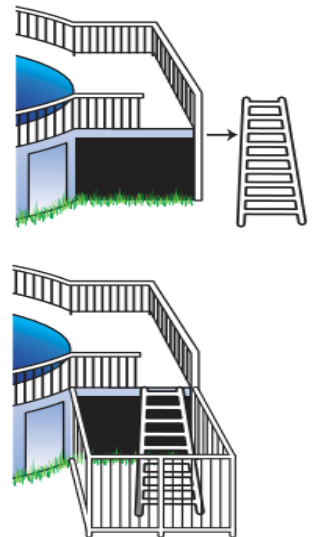

Gates located in the enclosure must swing away from the pool and have a self-closing and self-latching device. Where the release mechanism self-latching device is located less than 54" from the bottom of the gate, the release mechanism shall be located on the poolside of the gate at least 3" below the top of the gate. The gate and barrier must have no opening greater than 1/2" within 18" of the release mechanism. This prevents a child from reaching over the top of the gate and releasing the latch.

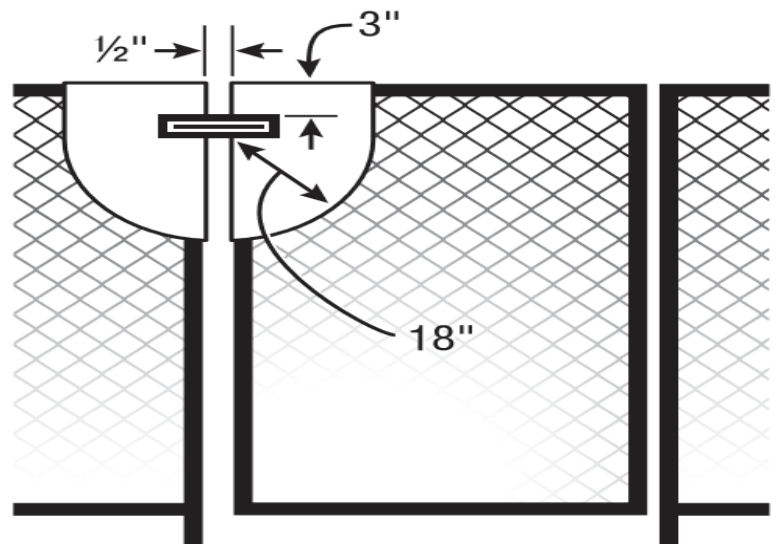

### When the House Wall Forms Part of the Pool Barrier:

If the pool barrier is part of a house wall, garage wall, shed wall, and/or similar structure, and there are access door(s) in the barrier walls, a door alarm must be installed and mounted on the side of the door or screen door opposite the pool. This alarm must produce an audible warning when the door or screen door are opened. The alarm shall activate within 7 seconds after the door is opened and sound continuously for a minimum of 30 seconds. The alarm must be able to be heard throughout the house. The alarm must automatically reset under all conditions. The alarm must be equipped with a manual touch pad or switch that allows adults to temporarily deactivate the alarm for no more than 15 seconds. The deactivation touch pad or switch must be located at least 54" above the threshold of the door covered by the alarm.

Approved power safety covers can also be installed on pools to serve as security barriers. Spas or hot tubs installed with an approved safety cover are exempt from the above barrier requirements.



### ELECTRICAL WIRING REQUIREMENTS

All electrical components must comply with the applicable requirements of Chapter 42 of the *2015 International Residential Code* or *Article 680 of the 2014 National Electrical Code*.

#### 1. Storable Pool Pumps

- A. A cord-connected pool filter must incorporate an approved system of double insulation or equivalent.
- B. Cord-connected pool filter pumps must be provided with a ground-fault circuit interrupter (GFCI) that is an integral part of the attached plug or located in the power supply cord within 12" of the attached plug.
- C. Extension cords are not permitted to be used to extend the reach of the pool filter pump motor cord.

#### 2. Receptacle (Outlet) and Wiring Method for Storable Pool Pump

- A. Receptacles cannot be located within 6' of the inside wall of a storable pool.
- B. All receptacles located within 20' of the inside walls of a storable pool must be grounded and GFCI protected.
- C. Receptacles must have an **extra-duty, in-use, weatherproof cover** that can be closed when the cord is plugged in.
- D. Wiring:
  - UF cable, if buried, must be at least 24" deep (12" if GFCI protected).
  - Nonmetallic (PVC) conduit\* must be buried at least 18" below grade (12" if GFCI protected).
  - Rigid metal conduit\* must be buried at least 6" below grade.\* All wires used in conduit must be single strand wires (ex: THWN, etc. - **No NM or UF Cable in conduit**).

#### 3. Luminaries (lights) for Storable Pools (if used)

- A. Luminaries cannot have exposed metal parts and must be listed for the purpose.
- B. Luminaries 15 Volts or Less Must:
  - Have a luminaire lamp that operates at 15 volts or less
  - Have an impact-resistant polymeric lens, luminaire body, and a transformer enclosure
  - Have a transformer listed for swimming pools with a primary rating not over 150 volts
- C. Luminaries Over 15 Volts But Not Over 150 Volts:
  - Have an impact-resistant polymeric lens and luminaire body
  - Have Ground Fault Circuit Interrupter (GFCI) protection

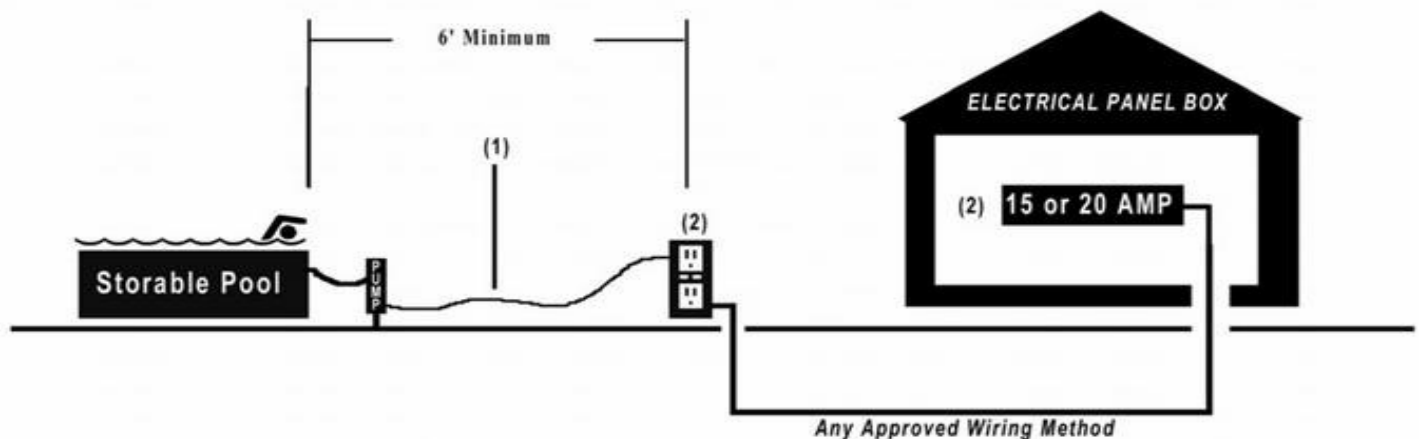

## **INSPECTIONS REQUIRED**

All work needs to be inspected prior to coverage or concealment. Call the Code Enforcement Officer at (716) 665-4400 **AT LEAST 2 DAYS IN ADVANCE** to schedule an inspection unless prior inspection arrangements have been made. Any work that is covered and not inspected, will be subject to uncovering. A Certificate of Compliance will not be issued unless all required inspections have been performed by the Code Enforcement Officer.

The following inspections are required to be performed:

- **ELECTRICAL INSPECTION** - For any newly installed electrical equipment or wiring, it must be inspected by a certified third-party inspection agency before portion of the system is concealed from view. Any unsafe condition may also require an inspection at the discretion of the Code Enforcement Officer. It is the responsibility of the applicant to obtain the required electrical inspections.

The following inspection agencies are approved to perform electrical inspections within the Town of Charlotte:

*Electrical Inspections of WNY, John Christopher Dean - (716) 224-0700*

*Gleason Enterprises, Mike Gleason - (716) 338-7108*

Other agencies or inspectors may only be used with prior approval by the Code Enforcement Officer.

An electrical inspection will not be required for subsequent pool re-installations as long as the pool is installed in the same location and no changes were made to any electrical components.

- **DECK INSPECTION** - If a deck is installed or constructed, an inspection of the footings, framing, railing & gate is required. (A separate building permit is required and structural plans must be submitted for review at the time of application).
- **FINAL INSPECTION** - A final inspection of the pool installation and required barriers must be performed upon completion and before use. If required, the electrical inspection must be performed prior to final inspection. **The pool cannot be filled with water unless the proper barriers are in place.**

Once the required inspections have been satisfactorily completed, a Certificate of Compliance will be issued and the pool may be used.

## **REINSTALLATION OR REPLACEMENT**

Whenever an existing pool is taken down and reinstalled, it must be placed in the same location. If installed in a new location or a new pool is installed, a new building permit must be obtained to ensure proper installation and placement. Changes to any electrical components associated with the pool, requires an electrical permit and inspections to be performed.

For further assistance and information, contact:  
**Town of Charlotte Code Enforcement Department**  
8 Lester Street, P.O. Box 482  
Sinclairville, New York 14782  
Phone: (716) 962-6047  
Fax: (716) 962-3843  
Cell: (716) 450-3032  
Email: townofcharlotteceo@outlook.com